

Dell™ Inspiron™ 1011 Service Manual

[Before You Begin](#)

[Battery](#)

[Keyboard](#)

[Hard Drive](#)

[Palm Rest](#)

[Palm Rest Bracket](#)

[Communication Cards](#)

[Power/Battery Status Light Board](#)

[Speakers](#)

[Internal Card With Bluetooth® Wireless Technology](#)

[Power Button Board](#)

[USB and SIM Card Board](#)

[AC Adapter Connector](#)

[System Board](#)

[Memory](#)

[Coin-Cell Battery](#)

[Display](#)

[Camera](#)

[Flashing the BIOS](#)

Notes, Cautions, and Warnings



NOTE: A NOTE indicates important information that helps you make better use of your computer.



CAUTION: A CAUTION indicates either potential damage to hardware or loss of data and tells you how to avoid the problem.



WARNING: A WARNING indicates a potential for property damage, personal injury, or death.

Information in this document is subject to change without notice.
© 2009 Dell Inc. All rights reserved.

Reproduction of these materials in any manner whatsoever without the written permission of Dell Inc. is strictly forbidden.

Trademarks used in this text: *Dell*, the *DELL* logo, and *Inspiron* are trademarks of Dell Inc.; *Bluetooth* is a registered trademark owned by Bluetooth SIG, Inc. and is used by Dell under license; *Microsoft* and *Windows* are either trademarks or registered trademarks of Microsoft Corporation in the United States and/or other countries.

Other trademarks and trade names may be used in this document to refer to either the entities claiming the marks and names or their products. Dell Inc. disclaims any proprietary interest in trademarks and trade names other than its own.

Model PP19S

April 2009 Rev. A00

AC Adapter Connector

Dell™ Inspiron™ 1011 Service Manual

- [Removing the AC Adapter Connector](#)
- [Replacing the AC Adapter Connector](#)

- ⚠ WARNING:** Before working inside your computer, read the safety information that shipped with your computer. For additional safety best practices information, see the Regulatory Compliance Homepage at www.dell.com/regulatory_compliance.
- ⚠ CAUTION:** To avoid electrostatic discharge, ground yourself by using a wrist grounding strap or by periodically touching an unpainted metal surface.
- ⚠ CAUTION:** Only a certified service technician should perform repairs on your computer. Damage due to servicing that is not authorized by Dell™ is not covered by your warranty.
- ⚠ CAUTION:** To help prevent damage to the system board, remove the main battery (see [Removing the Battery](#)) before working inside the computer.
-

Removing the AC Adapter Connector

1. Follow the instructions in [Before You Begin](#).
2. Remove the battery (see [Removing the Battery](#)).
3. Remove the keyboard (see [Removing the Keyboard](#)).
4. Remove the palm rest (see [Removing the Palm Rest](#)).
5. Remove the hard drive (see [Removing the Hard Drive](#)).
6. Remove the palm rest bracket (see [Removing the Palm Rest Bracket](#)).
7. Remove the USB and SIM card board (see [Removing the USB and SIM Card Board](#)).
8. Disconnect the AC adapter connector cable from the system board connector.
9. Lift the AC adapter connector out of the computer base.

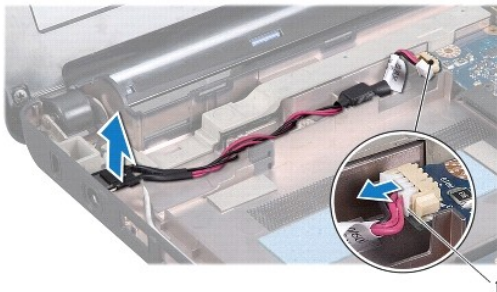

1	AC adapter cable connector
---	----------------------------

Replacing the AC Adapter Connector

1. Place the AC adapter connector on the system board.
2. Connect the AC adapter connector cable to the system board connector.
3. Replace the USB and SIM card board (see [Replacing the USB and SIM Card Board](#)).

-
4. Replace the palm rest bracket (see [Replacing the Palm Rest Bracket](#)).
 5. Replace the hard drive (see [Replacing the Hard Drive](#)).
 6. Replace the palm rest (see [Replacing the Palm Rest](#)).
 7. Replace the keyboard (see [Replacing the Keyboard](#)).
 8. Replace the battery (see [Replacing the Battery](#)).

[Back to Contents Page](#)

Power/Battery Status Light Board

Dell™ Inspiron™ 1011 Service Manual

- [Removing the Power/Battery Status Light Board](#)
- [Replacing the Power/Battery Status Light Board](#)

- WARNING:** Before working inside your computer, read the safety information that shipped with your computer. For additional safety best practices information, see the Regulatory Compliance Homepage at www.dell.com/regulatory_compliance.
- CAUTION:** To avoid electrostatic discharge, ground yourself by using a wrist grounding strap or by periodically touching an unpainted metal surface.
- CAUTION:** Only a certified service technician should perform repairs on your computer. Damage due to servicing that is not authorized by Dell™ is not covered by your warranty.
- CAUTION:** To help prevent damage to the system board, remove the main battery (see [Removing the Battery](#)) before working inside the computer.
-

Removing the Power/Battery Status Light Board

1. Follow the instructions in [Before You Begin](#).
2. Remove the battery (see [Removing the Battery](#)).
3. Remove the keyboard (see [Removing the Keyboard](#)).
4. Remove the palm rest (see [Removing the Palm Rest](#)).
5. Remove the hard drive (see [Removing the Hard Drive](#)).
6. Remove the palm rest bracket (see [Removing the Palm Rest Bracket](#)).
7. Disconnect the power/battery status light board cable from the system board connector, if you have not already done so while removing the palm rest bracket.
8. Lift the power/battery status light board off the computer base.

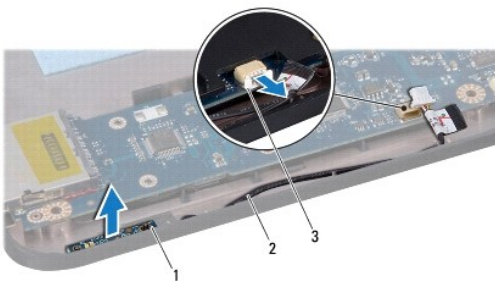

1	power/battery status light board	2	power/battery status light board cable
3	power/battery status light board cable connector		

Replacing the Power/Battery Status Light Board

1. Align the holes on the power/battery status light board to the protrusion on the computer base and keep it in place.
2. Connect the power/battery status light board cable to the system board connector.
3. Replace the palm rest bracket (see [Replacing the Palm Rest Bracket](#)).

4. Replace the hard drive (see [Replacing the Hard Drive](#)).
 5. Replace the palm rest (see [Replacing the Palm Rest](#)).
 6. Replace the keyboard (see [Replacing the Keyboard](#)).
 7. Replace the battery (see [Replacing the Battery](#)).
-

[Back to Contents Page](#)

[Back to Contents Page](#)

Before You Begin

Dell™ Inspiron™ 1011 Service Manual

- [Recommended Tools](#)
- [Turning Off Your Computer](#)
- [Before Working Inside Your Computer](#)

This section provides procedures for removing and installing components in your computer. Unless otherwise noted, each procedure assumes that the following conditions exist:

- 1 You have performed the steps in [Turning Off Your Computer](#) and [Before Working Inside Your Computer](#).
- 1 You have read the safety information that shipped with your computer.
- 1 A component can be replaced or—if purchased separately—installed by performing the removal procedure in the reverse order.

Recommended Tools

The procedures in this document may require the following tools:

- 1 Small flat-blade screwdriver
- 1 Phillips screwdriver
- 1 Plastic scribe
- 1 BIOS upgrade CD or the BIOS executable update program available on the Dell Support website at support.dell.com

Turning Off Your Computer

 **CAUTION:** To avoid losing data, save and close all open files and exit all open programs before you turn off your computer.

1. Save and close all open files and exit all open programs.
2. Shut down the operating system:

Windows® XP:

Click **Start** → **Shut Down** → **Shut down**.

Ubuntu® Dell Desktop:

Click  → **Quit**  → **Shut down**.

Ubuntu Classic Desktop:

Click  → **Shut down**.

3. Ensure that the computer and all attached devices are turned off. If your computer and attached devices did not automatically turn off when you shut down your operating system, press and hold the power button until the computer turns off.

Before Working Inside Your Computer

Use the following safety guidelines to help protect your computer from potential damage and to help to ensure your own personal safety.

 **WARNING:** Before working inside your computer, read the safety information that shipped with your computer. For additional safety best practices information, see the Regulatory Compliance Homepage at www.dell.com/regulatory_compliance.

 **CAUTION:** Handle components and cards with care. Do not touch the components or contacts on a card. Hold a card by its edges or by its metal mounting bracket. Hold a component such as a processor by its edges, not by its pins.

 **CAUTION:** Only a certified service technician should perform repairs on your computer. Damage due to servicing that is not authorized by Dell is not covered by your warranty.

 **CAUTION:** When you disconnect a cable, pull on its connector or on its pull-tab, not on the cable itself. Some cables have connectors with locking tabs; if you are disconnecting this type of cable, press in on the locking tabs before you disconnect the cable. As you pull connectors apart, keep

them evenly aligned to avoid bending any connector pins. Also, before you connect a cable, ensure that both connectors are correctly oriented and aligned.

 **CAUTION:** To avoid damaging the computer, perform the following steps before you begin working inside the computer.

1. Ensure that the work surface is flat and clean to prevent the computer cover from being scratched.
2. Turn off your computer. See [Turning Off Your Computer](#).

 **CAUTION:** To disconnect a network cable, first unplug the cable from your computer and then unplug the cable from the network device.

3. Disconnect all telephone or network cables from the computer.
4. Press and eject any installed cards from the Memory Card Reader.
5. Disconnect your computer and all attached devices from their electrical outlets.
6. Remove the battery (see [Removing the Battery](#)).
7. Turn the computer top-side up, open the display, and press the power button to ground the system board.

[Back to Contents Page](#)

[Back to Contents Page](#)

Flashing the BIOS

Dell™ Inspiron™ 1011 Service Manual

- [Flashing the BIOS From a CD](#)
- [Flashing the BIOS From the Hard Drive](#)
- [Flashing the BIOS in Ubuntu](#)

If a BIOS-update program CD is provided with the new system board, flash the BIOS from the CD. If you do not have a BIOS-update program CD, flash the BIOS from the hard drive.

 **NOTE:** Your computer does not have an internal optical drive. Use an external optical drive or any external storage device for the procedures that involve discs.

Flashing the BIOS From a CD

1. Ensure that the AC adapter is plugged in and that the main battery is installed properly.

 **NOTE:** If you use a BIOS-update program CD to flash the BIOS, set up the computer to boot from a CD before inserting the CD.

2. Insert the BIOS-update program CD, and restart the computer. Follow the instructions that appear on the screen. The computer continues to boot and updates the new BIOS. When the flash update is complete, the computer will automatically restart.
 3. Press <F2> during POST to enter the system setup program.
 4. Press <F9> to reset the computer defaults.
 5. Press <Esc>, select **Save changes and reboot**, and press <Enter> to save configuration changes.
 6. Remove the BIOS-update program CD from the drive and restart the computer.
-

Flashing the BIOS From the Hard Drive

1. Ensure that the AC adapter is plugged in, the main battery is properly installed, and a network cable is attached.
 2. Turn on the computer.
 3. Locate the latest BIOS update file for your computer at support.dell.com.
 4. Click **Download Now** to download the file.
 5. If the **Export Compliance Disclaimer** window appears, click **Yes, I Accept this Agreement**. The **File Download** window appears.
 6. Click **Save this program to disk** and then click **OK**. The **Save In** window appears.
 7. Click the down arrow to view the **Save In** menu, select **Desktop**, and then click **Save**. The file downloads to your desktop.
 8. Click **Close** if the **Download Complete** window appears. The file icon appears on your desktop and is titled the same as the downloaded BIOS update file.
 9. Double-click the file icon on the desktop and follow the instructions on the screen.
-

Flashing the BIOS in Ubuntu

1. Ensure that the AC adapter is plugged in, the main battery is properly installed, and a network cable is attached.
2. Turn on the computer.

3. Select  → **Places** → **Documents**.
 4. Create a new folder and name it **BIOS**.
 5. Locate the latest BIOS update file for your computer at support.dell.com.
 6. Click **Download Now** to download the file.
 7. If the **Export Compliance Disclaimer** window appears, click **Yes, I Accept this Agreement**.
The **File Download** window appears.
 8. Click **Save this program to disk** and then click **OK**.
The **Save In** window appears.
 9. Click the down arrow to view the **Save In** menu, select **Documents** → **BIOS**, and then click **Save**.
 10. Click **Close** if the **Download Complete** window appears.
The file icon appears on your BIOS folder and is titled the same as the downloaded BIOS update file.
 11. Open the terminal command line application and proceed as follows:
 - a. Type `sudo -s`
 - b. Type your password
 - c. Type `cd Documents`
 - d. Type `cd BIOS`
 - e. Type `./1011a00`

`flash start...` string appears.

The computer will restart automatically once the BIOS flash is complete.
-

[Back to Contents Page](#)

[Back to Contents Page](#)

Internal Card With Bluetooth® Wireless Technology

Dell™ Inspiron™ 1011 Service Manual

- [Removing the Bluetooth Card](#)
- [Replacing the Bluetooth Card](#)

- WARNING:** Before working inside your computer, read the safety information that shipped with your computer. For additional safety best practices information, see the Regulatory Compliance Homepage at www.dell.com/regulatory_compliance.
- CAUTION:** To avoid electrostatic discharge, ground yourself by using a wrist grounding strap or by periodically touching an unpainted metal surface.
- CAUTION:** Only a certified service technician should perform repairs on your computer. Damage due to servicing that is not authorized by Dell™ is not covered by your warranty.
- CAUTION:** To help prevent damage to the system board, remove the main battery (see [Removing the Battery](#)) before working inside the computer.

If you ordered a card with Bluetooth wireless technology with your computer, it is already installed.

Removing the Bluetooth Card

1. Follow the instructions in [Before You Begin](#).
2. Remove the battery (see [Removing the Battery](#)).
3. Remove the keyboard (see [Removing the Keyboard](#)).
4. Remove the palm rest (see [Removing the Palm Rest](#)).
5. Remove the hard drive (see [Removing the Hard Drive](#)).
6. Remove the palm rest bracket (see [Removing the Palm Rest Bracket](#)).
7. Push the card out of the Bluetooth card compartment in the palm rest bracket.

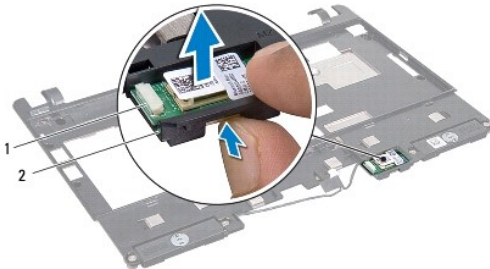

1	Bluetooth card	2	Bluetooth card compartment
---	----------------	---	----------------------------

Replacing the Bluetooth Card

1. Place the card in the Bluetooth card compartment and snap it into place.
2. Replace the palm rest bracket (see [Replacing the Palm Rest Bracket](#)).
3. Replace the hard drive (see [Replacing the Hard Drive](#)).
4. Replace the palm rest (see [Replacing the Palm Rest](#)).
5. Replace the keyboard (see [Replacing the Keyboard](#)).

6. Replace the battery (see [Replacing the Battery](#)).

[Back to Contents Page](#)

Camera

Dell™ Inspiron™ 1011 Service Manual

- [Removing the Camera](#)
- [Replacing the Camera](#)

- WARNING:** Before working inside your computer, read the safety information that shipped with your computer. For additional safety best practices information, see the Regulatory Compliance Homepage at www.dell.com/regulatory_compliance.
- CAUTION:** To avoid electrostatic discharge, ground yourself by using a wrist grounding strap or by periodically touching an unpainted metal surface (such as a connector on the back of the computer).
- CAUTION:** Only a certified service technician should perform repairs on your computer. Damage due to servicing that is not authorized by Dell™ is not covered by your warranty.
- CAUTION:** To help prevent damage to the system board, remove the main battery (see [Removing the Battery](#)) before working inside the computer.
-

Removing the Camera

1. Follow the instructions in [Before You Begin](#).
2. Remove the display bezel (see [Removing the Display Bezel](#)).

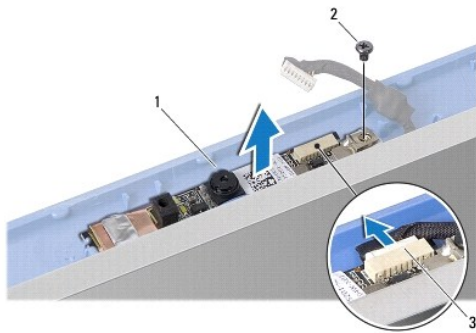

1	camera	2	screw
3	camera cable connector		

3. Remove the screw that secures the camera to the display cover.
 4. Disconnect the camera cable from the connector.
 5. Remove the camera board.
-

Replacing the Camera

1. Connect the camera cable to the connector.
 2. Align the screw hole on the camera board with the screw hole on the display cover.
 3. Replace the screw that secures the camera to the display cover.
 4. Replace the display bezel (see [Replacing the Display Bezel](#)).
-

[Back to Contents Page](#)

Coin-Cell Battery

Dell™ Inspiron™ 1011 Service Manual

- [Removing the Coin-Cell Battery](#)
- [Replacing the Coin-Cell Battery](#)

- WARNING:** Before working inside your computer, read the safety information that shipped with your computer. For additional safety best practices information, see the Regulatory Compliance Homepage at www.dell.com/regulatory_compliance.
- CAUTION:** To avoid electrostatic discharge, ground yourself by using a wrist grounding strap or by periodically touching an unpainted metal surface.
- CAUTION:** Only a certified service technician should perform repairs on your computer. Damage due to servicing that is not authorized by Dell™ is not covered by your warranty.
- CAUTION:** To help prevent damage to the system board, remove the main battery (see [Removing the Battery](#)) before working inside the computer.
-

Removing the Coin-Cell Battery

1. Follow the instructions in [Before You Begin](#).
2. Follow the instructions from [step 2](#) to [step 10](#) in [Removing the System Board](#).

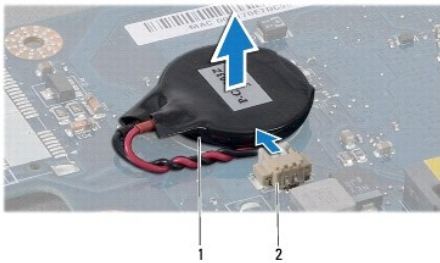

1	coin-cell battery	2	coin-cell battery cable connector
---	-------------------	---	-----------------------------------

3. Disconnect the coin-cell battery cable from the system board connector.
 4. Lift the coin-cell battery off the computer base.
-

Replacing the Coin-Cell Battery

1. Replace the coin-cell battery.
 2. Connect the coin-cell battery cable to the system board connector.
 3. Follow the instructions from [step 3](#) to [step 11](#) in [Replacing the System Board](#).
-

[Back to Contents Page](#)

Display

Dell™ Inspiron™ 1011 Service Manual

- [Display Assembly](#)
- [Display Bezel](#)
- [Display Panel](#)
- [Display Panel Cable](#)

- ⚠ WARNING:** Before working inside your computer, read the safety information that shipped with your computer. For additional safety best practices information, see the Regulatory Compliance Homepage at www.dell.com/regulatory_compliance.
- ⚠ CAUTION:** To avoid electrostatic discharge, ground yourself by using a wrist grounding strap or by periodically touching an unpainted metal surface.
- ⚠ CAUTION:** Only a certified service technician should perform repairs on your computer. Damage due to servicing that is not authorized by Dell™ is not covered by your warranty.
- ⚠ CAUTION:** To help prevent damage to the system board, remove the main battery (see [Removing the Battery](#)) before working inside the computer.
-

Display Assembly

Removing the Display Assembly

1. Follow the instructions in [Before You Begin](#).
2. Remove the battery (see [Removing the Battery](#)).
3. Remove the keyboard (see [Removing the Keyboard](#)).
4. Remove the palm rest (see [Removing the Palm Rest](#)).
5. Remove the hard drive (see [Removing the Hard Drive](#)).
6. Remove the palm rest bracket (see [Removing the Palm Rest Bracket](#)).
7. Remove the USB and SIM card board (see [Removing the USB and SIM Card Board](#)).
8. Remove the AC adapter connector (see [Removing the AC Adapter Connector](#)).
9. Remove the system board without removing the memory module and coin-cell battery (see [Removing the System Board](#)).
10. Make note of the Mini-Card cable routing and pull the Mini-Card cables out of the computer base.
11. Remove the two screws that secure the display assembly to the computer base.

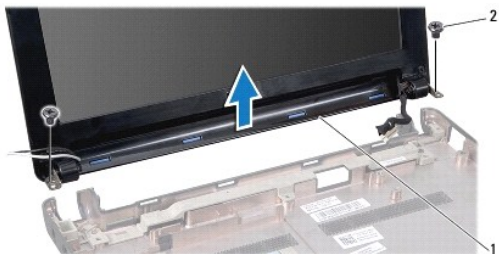

1	display assembly	2	screws (2)
---	------------------	---	------------

12. Lift and remove the display assembly from the computer base.

Replacing the Display Assembly

1. Place the display assembly in position and replace the two screws that secure the display assembly to the computer base.
 2. Route the Mini-Card cables and connect them to the Mini-Cards, if applicable (see [Replacing the Mini-Card](#)).
 3. Replace the system board (see [Replacing the System Board](#)).
 4. Replace the AC adapter connector (see [Replacing the AC Adapter Connector](#)).
 5. Replace the USB and SIM card board (see [Replacing the USB and SIM Card Board](#)).
 6. Replace the palm rest bracket (see [Replacing the Palm Rest Bracket](#)).
 7. Replace the hard drive (see [Replacing the Hard Drive](#)).
 8. Replace the palm rest (see [Replacing the Palm Rest](#)).
 9. Replace the keyboard (see [Replacing the Keyboard](#)).
 10. Replace the battery (see [Replacing the Battery](#)).
-

Display Bezel

Removing the Display Bezel

CAUTION: The display bezel is extremely fragile. Be careful when removing it to prevent damaging the bezel.

1. Remove the display assembly (see [Removing the Display Assembly](#)).
2. Press and remove the hinge cover caps (one on each side).

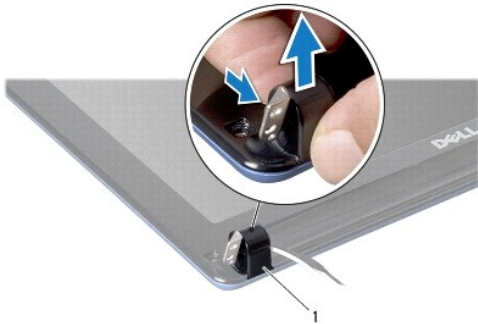

1 | hinge cover caps (2)

3. Remove the two rubber pads (one on either side) on the display bezel screws.
4. Remove the two screws on the display bezel.
5. Using your fingertips, carefully pry up the inside edge of the display bezel.



1	screws (2)	2	rubber pads (2)
3	display bezel		

6. Remove the display bezel.

Replacing the Display Bezel

1. Realign the display bezel over the display panel, and gently snap into place.
2. Replace the two screws that secure the display bezel.
3. Replace the two rubber pads (one on either side) on the display bezel screws.
4. Press and replace the hinge cover caps.
5. Replace the display assembly (see [Replacing the Display Assembly](#)).

Display Panel

Removing the Display Panel

1. Remove the display assembly (see [Removing the Display Assembly](#)).
2. Remove the display bezel (see [Removing the Display Bezel](#)).
3. Disconnect the camera cable from camera cable connector on the display cover.
4. Remove the four screws securing the display panel to the display cover.
5. Remove the display panel.

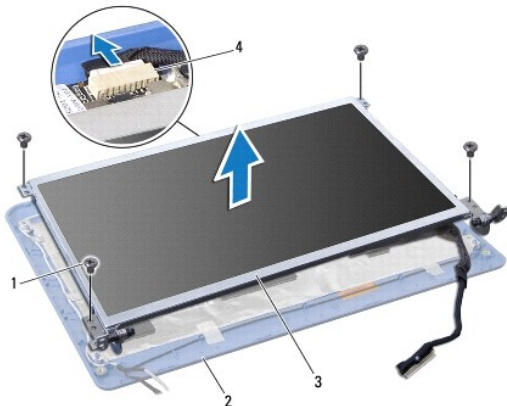

1	screws (4)	2	display cover
3	display panel	4	camera cable connector

- Remove the four screws (two on each side) that secure the display panel brackets to the display panel.

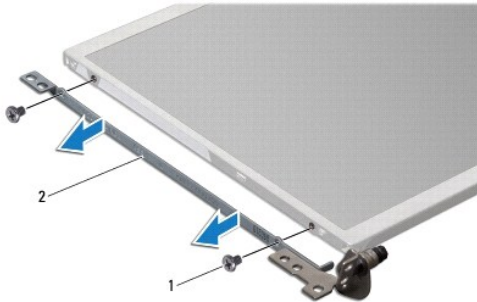

1	screws (4)	2	display panel brackets (2)
---	------------	---	----------------------------

Replacing the Display Panel

- Attach the display brackets to the display panel by replacing the two screws on each side of the display panel.
- Align the screw holes on the display panel with the holes on the display cover.
- Replace the four screws that secure the display panel to the display cover.
- Connect the camera cable to camera cable connector on the display cover.
- Replace the display bezel (see [Replacing the Display Bezel](#)).
- Replace the display assembly (see [Replacing the Display Assembly](#)).

Display Panel Cable

Removing the Display Panel Cable

- Follow the instructions in [Before You Begin](#).
- Remove the display assembly (see [Removing the Display Assembly](#)).
- Remove the display bezel (see [Removing the Display Bezel](#)).
- Remove the display panel (see [Removing the Display Panel](#)).
- Turn over the display panel and place it on a clean surface.
- Lift the conductive tape that secures the flex cable to the display board connector and disconnect the flex cable.

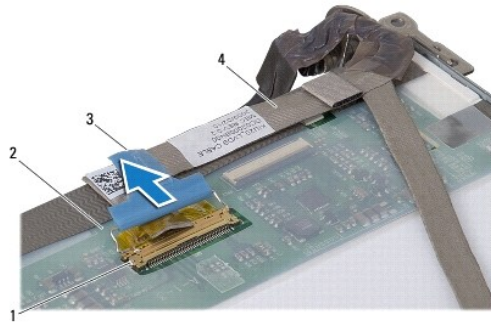

1	display board connector	2	back of display panel
3	conductive tape	4	flex cable

Replacing the Display Panel Cable

1. Connect the flex cable to the display board connector and secure it with the conductive tape.
2. Replace the display panel (see [Replacing the Display Panel](#)).
3. Replace the display bezel (see [Replacing the Display Bezel](#)).
4. Replace the display assembly (see [Replacing the Display Assembly](#)).

[Back to Contents Page](#)

Hard Drive

Dell™ Inspiron™ 1011 Service Manual

- [Removing the Hard Drive](#)
- [Replacing the Hard Drive](#)

- ⚠ **WARNING:** Before working inside your computer, read the safety information that shipped with your computer. For additional safety best practices information, see the Regulatory Compliance Homepage at www.dell.com/regulatory_compliance.
- ⚠ **WARNING:** If you remove the hard drive from the computer when the drive is hot, do not touch the metal housing of the hard drive.
- ⚠ **CAUTION:** To prevent data loss, turn off your computer (see [Turning Off Your Computer](#)) before removing the hard drive. Do not remove the hard drive while the computer is On or in Sleep state.
- ⚠ **CAUTION:** Hard drives are extremely fragile. Exercise care when handling the hard drive.
- ⚠ **CAUTION:** Only a certified service technician should perform repairs on your computer. Damage due to servicing that is not authorized by Dell is not covered by your warranty.
- ⚠ **CAUTION:** To help prevent damage to the system board, remove the main battery (see [Removing the Battery](#)) before working inside the computer.
- 📌 **NOTE:** Dell does not guarantee compatibility or provide support for hard drives from sources other than Dell.
- 📌 **NOTE:** If you are installing a hard drive from a source other than Dell, you need to install an operating system, drivers, and utilities on the new hard drive (see the *Dell Technology Guide*).

Removing the Hard Drive

1. Follow the procedures in [Before You Begin](#).
2. Remove the battery (see [Removing the Battery](#)).
3. Remove the keyboard (see [Removing the Keyboard](#)).

- ⚠ **CAUTION:** When the hard drive is not in the computer, store it in protective antistatic packaging (see "Protecting Against Electrostatic Discharge" in the safety instructions that shipped with your computer).

4. Remove the screw that secures the hard drive assembly to the computer base.
5. Pull the pull-tab towards the left to detach the hard drive assembly from the interposer.
6. Lift the hard drive assembly out of the hard drive compartment.

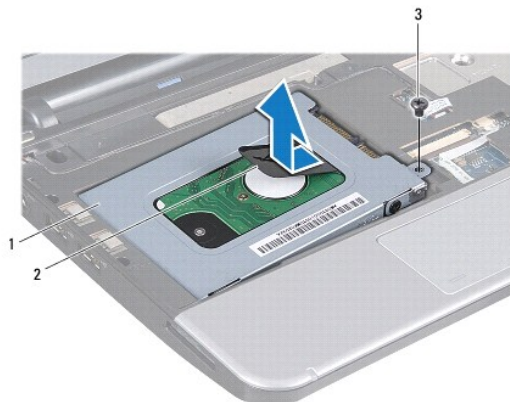

1	hard drive assembly	2	pull-tab	3	screw
---	---------------------	---	----------	---	-------

7. Remove the four screws that secure the hard drive bracket to the hard drive.
8. Lift the hard drive off the hard drive bracket.

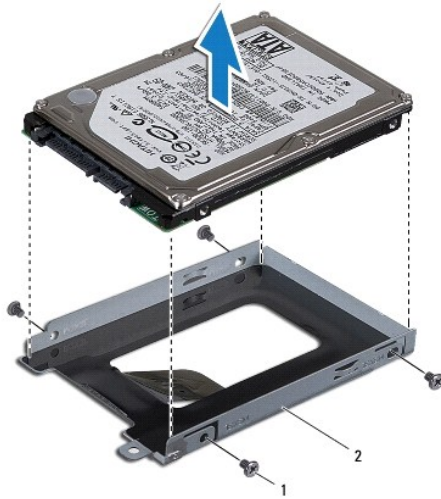

1	screws (4)	2	hard drive bracket
---	------------	---	--------------------

Replacing the Hard Drive

1. Remove the new hard drive from its packaging.
Save the original packaging for storing or shipping the hard drive.
2. Replace the four screws that secure the hard drive bracket to the hard drive.
3. Place the hard drive assembly in the hard drive compartment.
4. Push the hard drive into the interposer until it is fully connected.
5. Replace the screw that secures the hard drive assembly to the computer base.
6. Replace the keyboard (see [Replacing the Keyboard](#)).
7. Replace the battery (see [Replacing the Battery](#)).
8. Install the operating system for your computer, as needed. See "Restoring Your Operating System" in the *Setup Guide* or "Restoring Your Ubuntu System" in the *Ubuntu Quick Start Guide*.
9. Install the drivers and utilities for your computer, as needed. For more information, see the *Dell Technology Guide*.

[Back to Contents Page](#)

[Back to Contents Page](#)

Keyboard

Dell™ Inspiron™ 1011 Service Manual

- [Removing the Keyboard](#)
- [Replacing the Keyboard](#)

- WARNING:** Before working inside your computer, read the safety information that shipped with your computer. For additional safety best practices information, see the Regulatory Compliance Homepage at www.dell.com/regulatory_compliance.
- CAUTION:** To avoid electrostatic discharge, ground yourself by using a wrist grounding strap or by periodically touching an unpainted metal surface.
- CAUTION:** Only a certified service technician should perform repairs on your computer. Damage due to servicing that is not authorized by Dell™ is not covered by your warranty.
- CAUTION:** To help prevent damage to the system board, remove the main battery (see [Removing the Battery](#)) before working inside the computer.
-

Removing the Keyboard

1. Follow the procedures in [Before You Begin](#).
2. Remove the battery (see [Removing the Battery](#)).
3. Remove the three screws that secure the keyboard to the computer base.

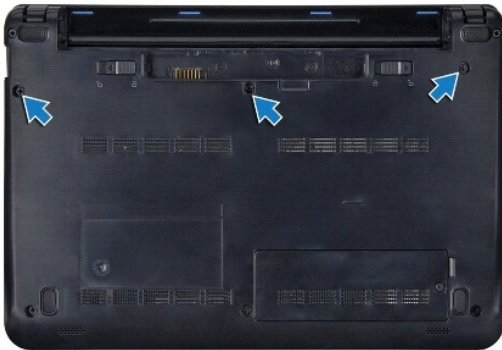

- CAUTION:** The keycaps on the keyboard are fragile, easily dislodged, and time-consuming to replace. Be careful when removing and handling the keyboard.
- CAUTION:** Be extremely careful when removing and handling the keyboard. Failure to do so could result in scratching the display panel.
4. Turn the computer over and open the display.
 5. Pry the center rear side of the keyboard by using your finger or a flat-blade screwdriver. Slightly release the left side of the keyboard and then the right side till it comes out from its base.
 6. Ease the keyboard up until it clears off the palm rest bracket.
 7. Without pulling hard on the keyboard, turn it over and place it over the palm rest.
 8. Release the keyboard cable locks on the system board connector and pull the pull-tab to disconnect the keyboard cable from the system board connector.

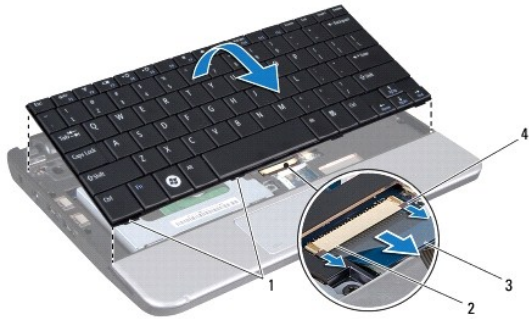

1	keyboard tabs (4)	2	keyboard cable connector
3	pull-tab	4	keyboard cable locks (2)

9. Lift the keyboard off the palm rest.
-

Replacing the Keyboard

1. Slide the keyboard cable into the connector on the system board and press down the keyboard cable locks on the system board connector.
 2. Align the four tabs on the keyboard to the slots on the palm rest bracket.
 3. Place the keyboard on the palm rest bracket.
 4. Turn the computer over and replace the three screws that secure the keyboard to the computer base.
 5. Replace the battery (see [Replacing the Battery](#)).
-

[Back to Contents Page](#)

Memory

Dell™ Inspiron™ 1011 Service Manual

- [Removing the Memory Module](#)
- [Replacing the Memory Module](#)

- WARNING:** Before working inside your computer, read the safety information that shipped with your computer. For additional safety best practices information, see the Regulatory Compliance Homepage at www.dell.com/regulatory_compliance.
- CAUTION:** To avoid electrostatic discharge, ground yourself by using a wrist grounding strap or by periodically touching an unpainted metal surface (such as a connector on the back of the computer).
- CAUTION:** Only a certified service technician should perform repairs on your computer. Damage due to servicing that is not authorized by Dell™ is not covered by your warranty.
- CAUTION:** To help prevent damage to the system board, remove the main battery (see [Removing the Battery](#)) before working inside the computer.
- NOTE:** Memory modules purchased from Dell™ are covered under your computer warranty.

Your computer has one user-accessible SODIMM socket.

Removing the Memory Module

1. Follow the instructions in [Before You Begin](#).
2. Follow the instructions from [step 2](#) to [step 10](#) in [Removing the System Board](#).

CAUTION: To prevent damage to the memory module connector, do not use tools to spread the memory module securing clips.

3. Use your fingertips to carefully spread apart the securing clips on each end of the memory module connector until the module pops up.
4. Remove the memory module from the memory module connector.

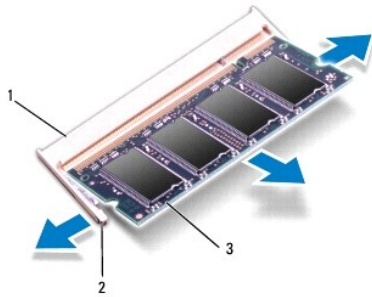

1	memory module connector	2	securing clips (2)
3	memory module		

Replacing the Memory Module

1. Align the notch in the memory module with the tab in the memory module connector.
2. Slide the module firmly into the slot at a 45-degree angle, and press the memory module down until it clicks into place. If you do not hear the click, remove the memory module and reinstall it.

NOTE: If the memory module is not installed properly, the computer may not boot.

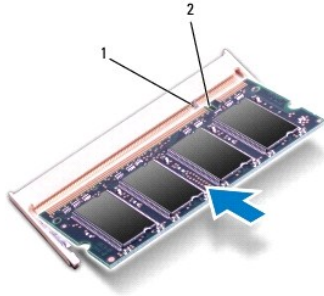

1	tab	2	notch
---	-----	---	-------

3. Follow the instructions from [step 3](#) to [step 10](#) in [Replacing the System Board](#).
4. Replace the battery (see [Replacing the Battery](#)), or connect the AC adapter to your computer and an electrical outlet.
5. Turn on the computer.

As the computer boots, it detects the memory module and automatically updates the system configuration information.

To confirm the amount of memory installed in the computer:

Windows® XP:

Right-click the **My Computer** icon on your desktop, then click **Properties**→ **General**.

Ubuntu®:

Click  → **System**→ **Administration**→ **System Monitor**.

[Back to Contents Page](#)

[Back to Contents Page](#)

Communication Cards

Dell™ Inspiron™ 1011 Service Manual

- [Subscriber Identity Module](#)
- [Wireless Mini-Cards](#)

Subscriber Identity Module

Subscriber Identity Module (SIM) identifies users uniquely through an International Mobile Subscriber Identity card.

⚠ WARNING: Before working inside your computer, read the safety information that shipped with your computer. For additional safety best practices information, see the Regulatory Compliance Homepage at www.dell.com/regulatory_compliance.

Installing the SIM

1. Follow the instructions in [Before You Begin](#).
2. Remove the battery (see [Removing the Battery](#)).
3. In the battery bay, slide the SIM into the compartment.
4. Replace the battery (see [Replacing the Battery](#)).



1	battery bay	2	SIM
---	-------------	---	-----

Removing the SIM

1. Remove the battery (see [Removing the Battery](#)).
2. Press the SIM into the compartment to release it. When it is partially ejected, remove the SIM from the battery bay.
3. Replace the battery (see [Replacing the Battery](#)).

Wireless Mini-Cards

⚠ WARNING: Before working inside your computer, read the safety information that shipped with your computer. For additional safety best practices information, see the Regulatory Compliance Homepage at www.dell.com/regulatory_compliance.

⚠ CAUTION: To avoid electrostatic discharge, ground yourself by using a wrist grounding strap or by periodically touching an unpainted metal surface.

⚠ CAUTION: Only a certified service technician should perform repairs on your computer. Damage due to servicing that is not authorized by Dell™ is not covered by your warranty.

⚠ CAUTION: To help prevent damage to the system board, remove the main battery (see [Removing the Battery](#)) before working inside the computer.

📌 NOTE: Dell does not guarantee compatibility or provide support for Mini-Cards from sources other than Dell.

If you ordered a wireless Mini-Card with your computer, the card is already installed.

Your computer supports two Mini-Card slots:

- 1 One full Mini-Card slot - for Mobile Broadband or Wireless Wide Area Network (WWAN)

- 1 One half Mini-Card slot - for Wireless Local Area Network (WLAN)

 **NOTE:** Depending on the configuration of the computer when it was sold, the Mini-Card slots may or may not have Mini-Cards installed in them.

Removing the Mini-Card

1. Follow the instructions in [Before You Begin](#).
2. Remove the battery (see [Removing the Battery](#)).
3. Loosen the captive screw on the mini door.

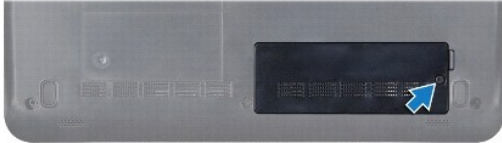

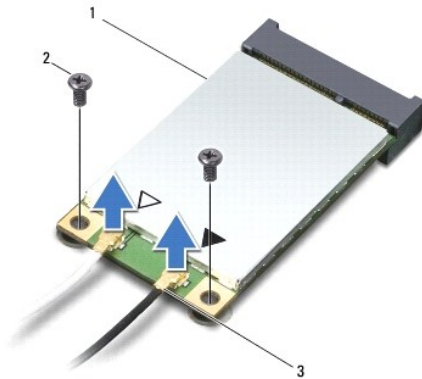

4. Disconnect the antenna cables from the Mini-Card.

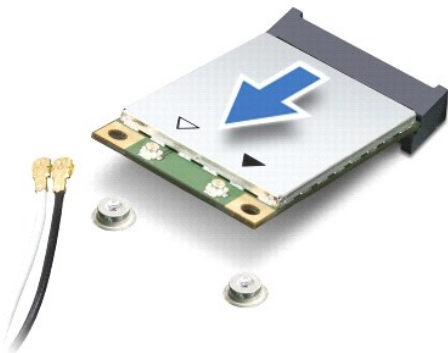

1	Mini-Card	2	screws (2)	3	antenna cable connectors (2)
---	-----------	---	------------	---	------------------------------

5. Release the Mini-Card by removing the two screws that secure the Mini-Card to the system board connector.
6. Lift the Mini-Card out of its system board connector.



 **CAUTION:** When the Mini-Card is not in the computer, store it in protective antistatic packaging (see "Protecting Against Electrostatic Discharge" in the safety instructions that shipped with your computer).

Replacing the Mini-Card

1. Remove the new Mini-Card from its packing.

 **CAUTION:** Use firm and even pressure to slide the card into place. If you use excessive force, you may damage the connector.

 **CAUTION:** The connectors are keyed to ensure correct insertion. If you feel resistance, check the connectors on the card and on the system board, and realign the card.

 **CAUTION:** To avoid damage to the Mini-Card, never place cables under the card.

2. Insert the Mini-Card at a 45-degree angle into the appropriate system board connector. For example, the WLAN card connector is labeled WLAN and so on.
3. Press the other end of the WLAN card down into the slot on the system board and replace the two screws that secure the card to the system board connector.
4. Connect the appropriate antenna cables to the Mini-Card you are installing. The following table provides the antenna cable color scheme for each Mini-Card supported by your computer.

Connectors on the Mini-Card	Antenna Cable Color Scheme
WWAN (2 antenna cables)	
Main WWAN (white triangle)	white with gray stripe
Auxiliary WWAN (black triangle)	black with gray stripe
WLAN (2 antenna cables)	
Main WLAN (white triangle)	white
Auxiliary WLAN (black triangle)	black

5. Secure unused antenna cables in the protective mylar sleeve.
6. Replace and tighten the captive screw that secures the mini door to the base of the computer.
7. Replace the battery (see [Replacing the Battery](#)).
8. Install the drivers and utilities for your computer, as required. For more information, see the *Dell Technology Guide*.

 **NOTE:** If you are installing a communication card from a source other than Dell, you must install the appropriate drivers and utilities. For more generic driver information, see the *Dell Technology Guide*.

[Back to Contents Page](#)

Palm Rest

Dell™ Inspiron™ 1011 Service Manual

- [Removing the Palm Rest](#)
- [Replacing the Palm Rest](#)

- WARNING:** Before working inside your computer, read the safety information that shipped with your computer. For additional safety best practices information, see the Regulatory Compliance Homepage at www.dell.com/regulatory_compliance.
- CAUTION:** To avoid electrostatic discharge, ground yourself by using a wrist grounding strap or by periodically touching an unpainted metal surface.
- CAUTION:** Only a certified service technician should perform repairs on your computer. Damage due to servicing that is not authorized by Dell™ is not covered by your warranty.
- CAUTION:** To help prevent damage to the system board, remove the main battery (see [Removing the Battery](#)) before working inside the computer.
-

Removing the Palm Rest

1. Follow the instructions in [Before You Begin](#).
2. Remove the battery (see [Removing the Battery](#)).
3. Remove keyboard (see [Removing the Keyboard](#)).
4. Release the touch pad cable locks and disconnect the touch pad cable from the system board connector.

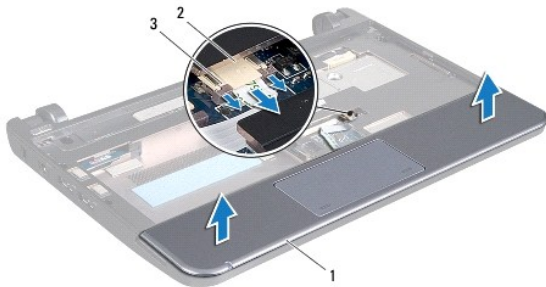

1	palm rest	2	touch pad cable connector
3	touch pad cable locks (2)		

- CAUTION:** Carefully separate the palm rest from the computer base to avoid damage to the palm rest.
5. Starting at the right/left of the palm rest, use your fingers to separate the palm rest from the palm rest bracket.
 6. Gently pull the touch pad cable out of the cable slot and lift the palm rest off the palm rest bracket.
-

Replacing the Palm Rest

1. Route the touch pad cable through the cable slot.
2. Align the palm rest on the palm rest bracket and gently snap the palm rest into place.
3. Slide the touch pad cable into the connector on the system board and press down the touch pad cable locks on the system board connector.
4. Replace the keyboard (see [Replacing the Keyboard](#)).
5. Replace the battery (see [Replacing the Battery](#)).

[Back to Contents Page](#)

[Back to Contents Page](#)

Palm Rest Bracket

Dell™ Inspiron™ 1011 Service Manual

- [Removing the Palm Rest Bracket](#)
- [Replacing the Palm Rest Bracket](#)

- WARNING:** Before working inside your computer, read the safety information that shipped with your computer. For additional safety best practices information, see the Regulatory Compliance Homepage at www.dell.com/regulatory_compliance.
- CAUTION:** To avoid electrostatic discharge, ground yourself by using a wrist grounding strap or by periodically touching an unpainted metal surface.
- CAUTION:** Only a certified service technician should perform repairs on your computer. Damage due to servicing that is not authorized by Dell™ is not covered by your warranty.
- CAUTION:** To help prevent damage to the system board, remove the main battery (see [Removing the Battery](#)) before working inside the computer.
-

Removing the Palm Rest Bracket

1. Follow the instructions in [Before You Begin](#).
2. Remove the battery (see [Removing the Battery](#)).
3. Remove the keyboard (see [Removing the Keyboard](#)).
4. Remove the palm rest (see [Removing the Palm Rest](#)).
5. Remove the hard drive (see [Removing the Hard Drive](#)).
6. Remove the five screws that secure the palm rest bracket to the computer base.

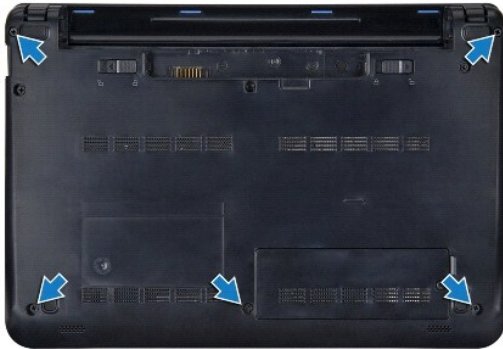

7. Turn the computer over and open the display.
8. Remove the four screws that secure the palm rest bracket.

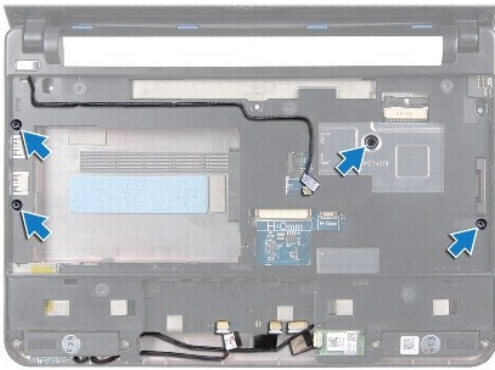

9. Disconnect the power button cable, Bluetooth card cable, power/battery status light cable, and speaker cable from their respective system board connectors.



1	power button cable connector	2	palm rest bracket
3	Bluetooth cable connector	4	speaker cable connector
5	power/battery status light cable connector		

10. Carefully lift the palm rest bracket along the rear edge, near the hinge brackets, then gently lift the palm rest bracket to remove it from the computer.

Replacing the Palm Rest Bracket

1. Place the palm rest bracket on the computer base and snap it into place.
2. Replace the four screws that secure the palm rest bracket.
3. Connect the power button cable, Bluetooth card cable, power/battery status light cable, and speaker cable to their respective system board connectors.
4. Replace the hard drive (see [Replacing the Hard Drive](#)).
5. Replace the palm rest (see [Replacing the Palm Rest](#)).
6. Replace the keyboard (see [Replacing the Keyboard](#)).
7. Replace the five screws that secure the palm rest bracket to the computer base.

8. Replace the battery (see [Replacing the Battery](#)).

[Back to Contents Page](#)

[Back to Contents Page](#)

Power Button Board

Dell™ Inspiron™ 1011 Service Manual

- [Removing the Power Button Board](#)
- [Replacing the Power Button Board](#)

- WARNING:** Before working inside your computer, read the safety information that shipped with your computer. For additional safety best practices information, see the Regulatory Compliance Homepage at www.dell.com/regulatory_compliance.
- CAUTION:** To avoid electrostatic discharge, ground yourself by using a wrist grounding strap or by periodically touching an unpainted metal surface.
- CAUTION:** Only a certified service technician should perform repairs on your computer. Damage due to servicing that is not authorized by Dell™ is not covered by your warranty.
- CAUTION:** To help prevent damage to the system board, remove the main battery (see [Removing the Battery](#)) before working inside the computer.
-

Removing the Power Button Board

1. Follow the instructions in [Before You Begin](#).
2. Remove the battery (see [Removing the Battery](#)).
3. Remove the keyboard (see [Removing the Keyboard](#)).
4. Remove the palm rest (see [Removing the Palm Rest](#)).
5. Remove the hard drive (see [Removing the Hard Drive](#)).
6. Remove the palm rest bracket (see [Removing the Palm Rest Bracket](#)).
7. Turn the palm rest bracket over and remove the screw that secures the power button board to the palm rest bracket.
8. Remove the power button cable from its routing.

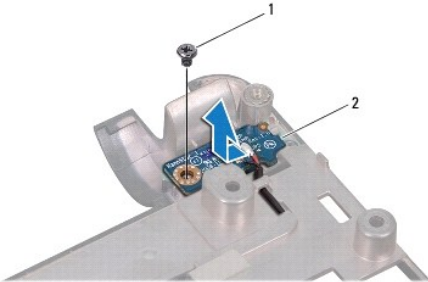

1	screw	2	power button board
---	-------	---	--------------------

9. Slide the power button board out of the palm rest bracket.
-

Replacing the Power Button Board

1. Slide the power button board to its place on the palm rest bracket.
2. Replace the screw that secures the power button board to the palm rest bracket.
3. Route the power button cable through its routing guide.
4. Replace the palm rest bracket (see [Replacing the Palm Rest Bracket](#)).

5. Replace the hard drive (see [Replacing the Hard Drive](#)).
6. Replace the palm rest (see [Replacing the Palm Rest](#)).
7. Replace the keyboard (see [Replacing the Keyboard](#)).
8. Replace the battery (see [Replacing the Battery](#)).

[Back to Contents Page](#)

Battery

Dell™ Inspiron™ 1011 Service Manual

- [Removing the Battery](#)
- [Replacing the Battery](#)

- WARNING:** Before working inside your computer, read the safety information that shipped with your computer. For additional safety best practices information, see the Regulatory Compliance Homepage at www.dell.com/regulatory_compliance.
- CAUTION:** To avoid electrostatic discharge, ground yourself by using a wrist grounding strap or by periodically touching an unpainted metal surface.
- CAUTION:** Only a certified service technician should perform repairs on your computer. Damage due to servicing that is not authorized by Dell™ is not covered by your warranty.
-

Removing the Battery

1. Shut down the computer and turn it over.

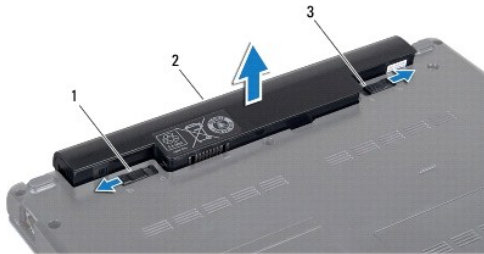

1	battery release latch	2	battery	3	battery lock latch
---	-----------------------	---	---------	---	--------------------

2. Slide the battery lock latch and battery release latch to unlock position.
 3. Pull the battery up and out of the battery bay.
-

Replacing the Battery

- CAUTION:** To avoid damage to the computer, use only the battery designed for this particular Dell computer. Do not use batteries designed for other Dell computers.

1. Slide the battery in the battery bay until it clicks into place.
 2. Slide the battery lock latch to the lock position.
-

Speakers

Dell™ Inspiron™ 1011 Service Manual

- [Removing the Speakers](#)
- [Replacing the Speakers](#)

- WARNING:** Before working inside your computer, read the safety information that shipped with your computer. For additional safety best practices information, see the Regulatory Compliance Homepage at www.dell.com/regulatory_compliance.
- CAUTION:** To avoid electrostatic discharge, ground yourself by using a wrist grounding strap or by periodically touching an unpainted metal surface.
- CAUTION:** Only a certified service technician should perform repairs on your computer. Damage due to servicing that is not authorized by Dell™ is not covered by your warranty.
- CAUTION:** To help prevent damage to the system board, remove the main battery (see [Removing the Battery](#)) before working inside the computer.
-

Removing the Speakers

1. Follow the instructions in [Before You Begin](#).
2. Remove the battery (see [Removing the Battery](#)).
3. Remove the keyboard (see [Removing the Keyboard](#)).
4. Remove the palm rest (see [Removing the Palm Rest](#)).
5. Remove the hard drive (see [Removing the Hard Drive](#)).
6. Remove the palm rest bracket (see [Removing the Palm Rest Bracket](#)).
7. Remove the four screws (two on each side) that secure the speakers to the palm rest bracket.
8. Lift the speakers off the palm rest bracket.

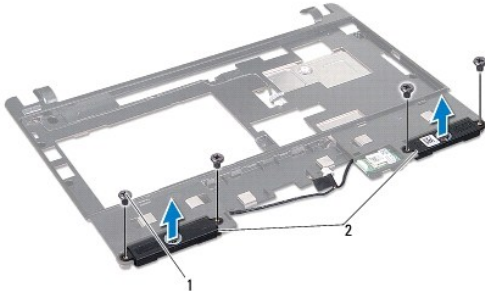

1	screws (4)	2	speakers
---	------------	---	----------

Replacing the Speakers

1. Place the speakers in the palm rest bracket and replace the four screws (two on each side) that secure the speakers to the palm rest bracket.
2. Replace the palm rest bracket (see [Replacing the Palm Rest Bracket](#)).
3. Replace the hard drive (see [Replacing the Hard Drive](#)).
4. Replace the palm rest (see [Replacing the Palm Rest](#)).
5. Replace the keyboard (see [Replacing the Keyboard](#)).

6. Replace the battery (see [Replacing the Battery](#)).

[Back to Contents Page](#)

System Board

Dell™ Inspiron™ 1011 Service Manual

- [Removing the System Board](#)
- [Replacing the System Board](#)
- [Entering the Service Tag in the BIOS](#)

- WARNING:** Before working inside your computer, read the safety information that shipped with your computer. For additional safety best practices information, see the Regulatory Compliance Homepage at www.dell.com/regulatory_compliance.
- CAUTION:** To avoid electrostatic discharge, ground yourself by using a wrist grounding strap or by periodically touching an unpainted metal surface.
- CAUTION:** Only a certified service technician should perform repairs on your computer. Damage due to servicing that is not authorized by Dell™ is not covered by your warranty.
- CAUTION:** To help prevent damage to the system board, remove the main battery (see [Removing the Battery](#)) before working inside the computer.

Removing the System Board

1. Follow the instructions in [Before You Begin](#).
2. Remove the battery (see [Removing the Battery](#)).
3. Remove the Mini-Card (see ["Removing the Mini-Card" on page 34](#)).
4. Remove the keyboard (see [Removing the Keyboard](#)).
5. Remove the palm rest (see [Removing the Palm Rest](#)).
6. Remove the hard drive (see [Removing the Hard Drive](#)).
7. Remove the palm rest bracket (see [Removing the Palm Rest Bracket](#)).
8. Disconnect the USB and SIM card board cable, AC adapter connector cable, and display cable from their respective system board connectors.
9. Remove the two screws that secure the system board to the computer base.

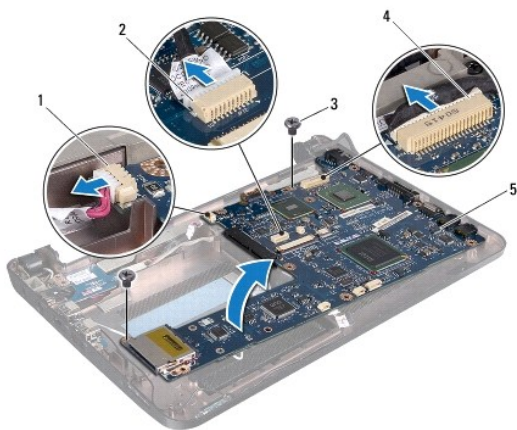

1	AC adapter cable connector	2	USB and SIM card cable connector
3	screws (2)	4	display cable connector
5	system board		

10. Lift the system board and turn it over.

11. Remove the memory module (see [Removing the Memory Module](#)).
 12. Remove the coin-cell battery (see [Removing the Coin-Cell Battery](#)).
-

Replacing the System Board

1. Replace the coin-cell battery (see [Replacing the Coin-Cell Battery](#)).
2. Replace the memory modules (see [Replacing the Memory Module](#)).
3. Turn the system board over.
4. Replace the two screws that secure the system board to the computer base.
5. Connect the USB and SIM card board cable, AC adapter connector cable, and display cable to their respective system board connectors.
6. Replace the palm rest bracket (see [Replacing the Palm Rest Bracket](#)).
7. Replace the hard drive (see [Replacing the Hard Drive](#)).
8. Replace the palm rest (see [Replacing the Palm Rest](#)).
9. Replace the keyboard (see [Replacing the Keyboard](#)).
10. Replace the Mini-Card (see [Replacing the Mini-Card](#)).
11. Replace the battery (see [Replacing the Battery](#)).

 **CAUTION:** Before turning on the computer, replace all screws and ensure that no stray screws remain inside the computer. Failure to do so may result in damage to the computer.

12. Turn on the computer.

 **NOTE:** After you have replaced the system board, enter the computer's Service Tag into the BIOS of the replacement system board.

13. Enter the service tag (see [Entering the Service Tag in the BIOS](#)).
-

Entering the Service Tag in the BIOS

1. Ensure that the AC adapter is plugged in and that the main battery is installed properly.
 2. Turn on the computer.
 3. Press <F2> during POST to enter the system setup program.
 4. Navigate to the security tab and enter the service tag in the **Set Service Tag** field.
-

[Back to Contents Page](#)

USB and SIM Card Board

Dell™ Inspiron™ 1011 Service Manual

- [Removing the USB and SIM Card Board](#)
- [Replacing the USB and SIM Card Board](#)

- WARNING:** Before working inside your computer, read the safety information that shipped with your computer. For additional safety best practices information, see the Regulatory Compliance Homepage at www.dell.com/regulatory_compliance.
- CAUTION:** To avoid electrostatic discharge, ground yourself by using a wrist grounding strap or by periodically touching an unpainted metal surface.
- CAUTION:** Only a certified service technician should perform repairs on your computer. Damage due to servicing that is not authorized by Dell™ is not covered by your warranty.
- CAUTION:** To help prevent damage to the system board, remove the main battery (see [Removing the Battery](#)) before working inside the computer.
-

Removing the USB and SIM Card Board

1. Follow the instructions in [Before You Begin](#).
2. Remove the battery (see [Removing the Battery](#)).
3. Remove the keyboard (see [Removing the Keyboard](#)).
4. Remove the palm rest (see [Removing the Palm Rest](#)).
5. Remove the hard drive (see [Removing the Hard Drive](#)).
6. Remove the palm rest bracket (see [Removing the Palm Rest Bracket](#)).
7. Disconnect the USB and SIM card board cable from the system board connector.
8. Remove the screw that secures the USB and SIM card board to the computer base.
9. Lift the USB and SIM card board out of the computer base.

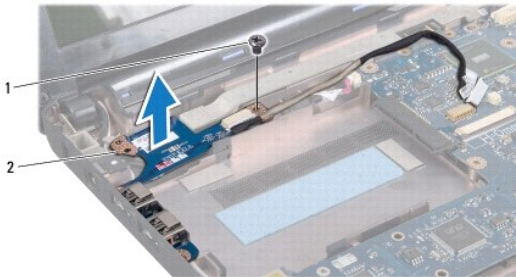

1	screw	2	USB and SIM card board
---	-------	---	------------------------

Replacing the USB and SIM Card Board

1. Align the holes on the USB and SIM card board to the protrusions on the computer base.
2. Replace the screw that secures the USB and SIM card board to the computer base.
3. Connect the USB and SIM card board cable to the system board connector.
4. Replace the palm rest bracket (see [Replacing the Palm Rest Bracket](#)).

5. Replace the hard drive (see [Replacing the Hard Drive](#)).
 6. Replace the palm rest (see [Replacing the Palm Rest](#)).
 7. Replace the keyboard (see [Replacing the Keyboard](#)).
 8. Replace the battery (see [Replacing the Battery](#)).
-

[Back to Contents Page](#)